



THE A. C. GILBERT COMPANY • ERECTOR SQUARE • NEW HAVEN, CONN.



MAKE  
DELICIOUS  
DESSERTS

# MY MIXER

TRADEMARK



**No. 14001 MY MIXER** — Now little daughter can make the dessert (for real!) with this new Gilbert Toy that's so much more than a toy! It's an actual hand-operated mixer, complete with bowl, safe nylon beaters and a unique proportioning scale that lets daughter easily and quickly measure the ingredients for cold desserts (16 party dessert recipes illustrated in full color included). New and unique, with steel and plastic parts that are easily disassembled for washing. Set also includes cat, clown and horse shaped molds to pour desserts into for chilling, plus a combination spatula, server and cutter. Easy, safe and fun for any little girl. The end result is an actual tasty dessert the whole family can enjoy!

LESS THAN \$15.00



BATHING  
IS FUN  
WITH  
BUBBLES!

# Scrubble Bubble

TRADEMARK



**No. 14101 SCRUBBLE BUBBLE** — Here's the newest break-through in bathing science — and it means more suds, fewer tears — cleaner youngsters, happier parents! What child could resist this wonderful new mother's helper that makes bathing really fun for the first time since tubs were invented? It's a combination scrubbing sponge and bubble blower! Uses any liquid soap and water. Funny face on the top is Disney's famous dwarf Dopey\*; bottom is soft plastic sponge. Rubbing action forms bubbles.

LESS THAN \$3.00

\* © Walt Disney Productions



**GILBERT****FAMILY  
FUN  
GAME**

# TUGGY

TRADEMARK



**No. 14201 TUGGY THE 2-HEADED TURTLE—**  
This looks easy until you try it yourself! If you can get it away from your delighted kids long enough, you'll see what we mean: You and your opponent each have two concealed remote-control buttons to push. They're wired to Tuggy's motor so that each player has to push the right button — at the right time — to move the turtle toward his opponent's goal line and knock it over to win. Each game is an electrical tug-of-war, with excitement mounting all the time. Set includes Tuggy, control box and two sets of finish-line markers. Tuggy's motor operates on safe battery power (batteries not included).

**LESS THAN \$15.00****GILBERT***sewhandy*

# SINGER

  
**SEWING MACHINES****No. 14325**

**"SEWHANDY" ELECTRIC**—A real little electric sewing machine that makes a perfect chain stitch. Presser foot acts as finger guard. The electric motor (plugs into 115 volt household A.C.) frees the right hand for more advanced sewing—and it's faster. Sleek metal machine with handy carry-case for storage. Complete with special sewing kit that includes material, patterns, thread, appliques and complete instructions for making colorful clothing bag.

**LESS THAN \$30.00**

**No. 14323 "SEWHANDY"**—Has all the exciting features of the No. 14325 machine, but is manually operated. Includes special sewing kit with complete instructions for making apron.

**LESS THAN \$20.00****GILBERT IS THE EXCLUSIVE  
DISTRIBUTOR IN THE TOY FIELD**

**GILBERT**
**FAMILY  
FUN  
GAME**

# HOCKEY



**No. 14301 HOT SHOT HOCKEY** — Offers real live hockey game action. The rugged "DYNA-DRIVE" steel gears stand up to continuous sizzling shots on goal. Good looking rounded corner rink with realistic hockey markings. Supplied with ball-type puck. Size is approx. 30" x 16". **LESS THAN \$10.00**

**No. 14302 ALL-STAR HOCKEY** — The All-Star hockey "men" move along the "ice" and diagonally across the "ice" on a play pattern designed for very fast passing and scoring action. The board is equipped with two full teams and has both a plain puck and a ball. Both ends have wrap-around "window" shields. Size is approx. 30" x 16".

**LESS THAN \$11.00**



**No. 14303 ELECTRIC CANADIAN HOCKEY GAME** — All the excitement and fun of real hockey! A king-size game with both "S"-shaped and curved slots for real skating action and shots close in on goal, fast behind-the-net passing. Features famous patented MAGNETIC PUCK for superb stick handling; AUTOMATIC RED GOAL LIGHT; realistic wrap-around window shields; SHOOTING GOALIE can clear down the "ice" or pass to defensemen. Includes MAGNETIC FACE-OFF, beautiful GON-DOLA SCOREBOARD, PATENTED PUCK CONTROLLERS, HEAVY DUTY STEEL GEARS. Size is approx. 20" x 36". Requires 2 size "D" batteries (not included), to operate goal lights.

**LESS THAN \$15.00**



**No. 14304 ELECTRIC NATIONAL HOCKEY GAME** — Has all the features of the No. 14303 plus: MAGNETIC END ZONE FACE-OFFS in the corners, heavier, deeper frame, large AUTOMATIC CLOCK TIMER supported over center-ice on clear plastic superstructure. An electric BUZZER sounds automatically at the end of each period. Size is approx. 20" x 36". Requires 3 size "D" batteries (not included), to operate goal lights.

**LESS THAN \$21.00**

**NOTE:** All hockey models normally supplied with 2 U. S. teams. Extra teams (2 other U. S. teams, or Toronto or Montreal) can be supplied at extra cost.



**GILBERT**
**PROJECT  
THE WONDERS  
OF THE  
MICROSCOPE  
WORLD**

# MICOLOGY



**No. 13134 MICOLOGY — Water Wonders Lab** — For use with Micro-Projector or Microscope, or independently, featuring study of marine life. Specimens include crayfish and frog. Dissecting equipment, stand, tray, magnifier, slides, color transparencies, Protozoa Pack and Growth Chamber, shrimp eggs, etc. Full color carton.

**LESS THAN \$10.00**

*New  
MICRO-  
PROJECTOR  
Most versatile  
instrument in the  
Science Toy field!*

They said it couldn't be done, but here it is, the ingenious new Gilbert Micro-Projector with exciting features no science toy has ever offered before: (1) Direct viewing of enlarged image on frosted screen for tracing or analysis by several people at once; (2) Projection of enlarged image on wall, screen, drawing pad or any convenient area; (3) Enlarging and projecting *either* opaque objects (with light above) such as biology specimens, stamps, coins, or regular glass slides and transparencies with sub-stage lighting; (4) Remove entire optical system and position it on opposite side to view very large objects!

## MICOLOGY

Unique new science sets that combine many fields into one: Biology, geology, mineralogy, microscopy — with a superb new optical instrument whose wide versatility takes it far beyond the toy field!



**No. 13135 MICOLOGY — Land Lore Lab** — For use with Micro-Projector or Microscope or independently, for study of land life. Biological specimens: earthworm and huge lubber grasshopper; also butterflies, fossils, etc., glass slides, color transparencies, professional dissecting equipment, "Picture-window" carton in full color.

**LESS THAN \$10.00**

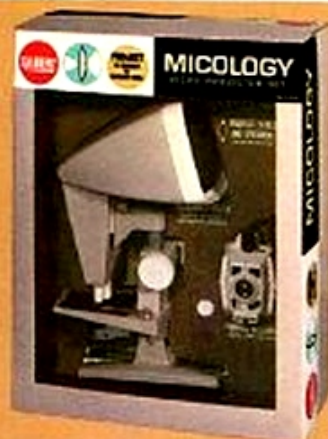

**No. 13136 MICOLOGY — Micro-Projector Set** — Project either opaque items — biology specimens, stamps, coins, etc. — or regular glass slides, magnified 5, 20 or 60 times. Far more than a toy, it has countless uses such as an aid in science homework, an instrument for collectors in many fields and all ages. Package has window and full color illustration.

**LESS THAN \$20.00**



**No. 13137 MICOLOGY — Micro-Projector Lab Set** — Includes the amazingly versatile new Gilbert Micro-Projector plus a large assortment of professional quality specimens and equipment: huge lubber grasshopper, crayfish, dissecting kit, laminated slides, 4-stage full-color transparencies, dissecting tray, etc. Package has window and full-color illustration.

**LESS THAN \$25.00**



# ERECTOR®

## For 1963... **ERECTOR** Brings You Completely New Concepts In Model Engineering

*..with exciting new Powermatic Accessories..  
all new solid shapes and colors..  
new modern tapered girders..  
new massive "3-D" parts for realism and versatility never  
before possible in any construction set!*

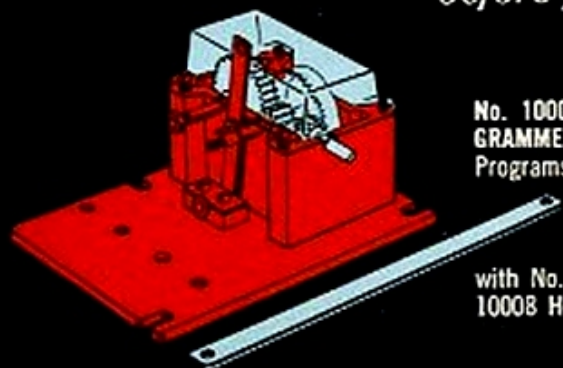

**No. 10009 POWER-MATIC PROGRAMMER**—It almost thinks! Programs a complete automatic sequence of movements in Erector models. Designed for use with No. 10007 Motor and No. 10008 Hoist. **LESS THAN \$5.00**

**No. 10008 POWER-MATIC HOIST**—A superb working miniature of the hoist mechanism used on freighters, giant cranes, docks, etc. Has 2 separate, independently operating drums. For use with No. 10007 Motor and No. 10009 Programmer. **LESS THAN \$5.00**



**New  
Tapered  
Girders**

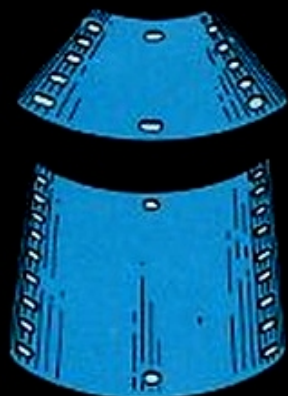

**New  
Curved  
Plates**



**New  
Curved  
Girders**



**No. 10006 POWER PACK**—Transforms 115 volt A.C. house current to 3 volts D.C. for operation of No. 10007 Power-Matic Motor, or any toy or device requiring this voltage. Has reversing switch. **LESS THAN \$7.00**



**No. 10007 POWER-MATIC MOTOR**—Powerful, rugged, versatile, reversible—operates on 3 volts D.C. from either Remote Control Battery Case or No. 10006 Power Pack. Three power take-off shafts. **LESS THAN \$5.00**

**No. 10002 ERECTOR MOTOR**—Forward-reverse, 4-position gear shift, U.L.-C.S.A. Approved. Operates on 120 volts, 60 cycle A.C. **LESS THAN \$8.00** (not illustrated.)

**GILBERT**
**WORLD'S  
GREATEST  
STEEL  
CONSTRUCTION  
SET**

# ERECTOR

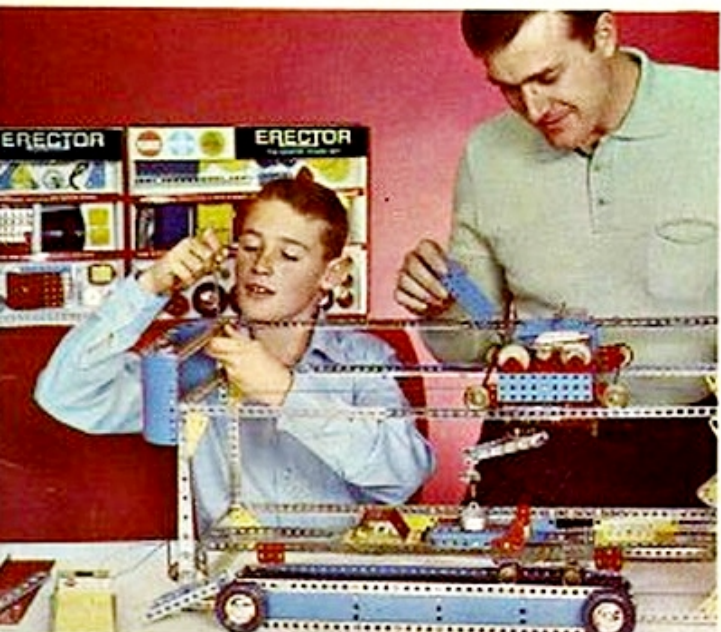
**NEW!**
**No. 10127 ERECTOR  
The Lunar Vehicle Set**

A whole new concept in construction sets — yet retaining the time-tested basic Erector nut-and-bolt building principle — making models so strong and rigid they can hold a man's weight! Redesigned pieces open up new horizons in model-making: With this set you can build such ultra-modern devices as Lunar Vehicle, Space Platform, Space Scanner, Radar Scope, Helicopter and many more — with exciting realism never before possible, even with Erector. New Power-Matic electric motor has Remote Control Battery Case with reversing switch.

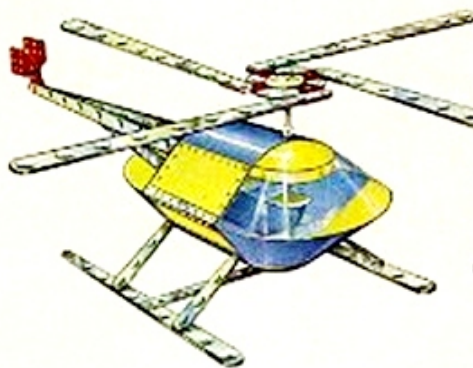
**LESS THAN \$23.00**

**NEW!**
**No. 10128 ERECTOR  
The Planetary Probe Set**

Build space era models such as the Planetary Probe, Rocket Service Gantry, Moon Bulldozer, Lunar Transmitters, Dual Inclined Railway, Floating Salvage Crane, etc. You can build these and many more, using the new tapered girders, new plates and shaped pieces plus new Power-Matic Motor with Remote Control Battery Case and new ingenious Power-Matic Hoist modeled after those used on ships.

**LESS THAN \$38.00**

**No. 10129 ERECTOR  
The Master Power Set**

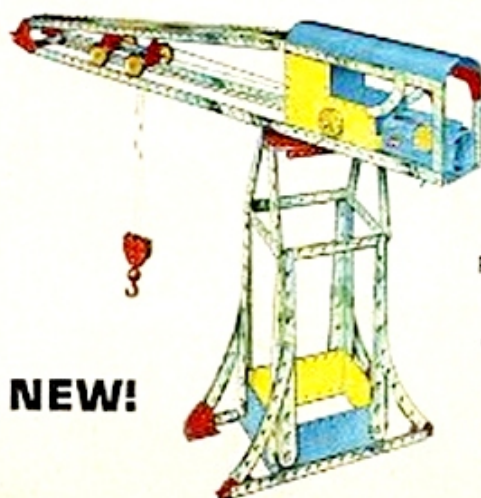
Build an operating Auto Assembly Line and dozens of other brand new, spectacular Space Age Models plus unlimited models of your own design! It's now made possible with the vast assortment of completely newly-designed girders, plates, shapes, wheels, and gears. New Power-Matic Motor operates from either Remote Control Battery Case or plug-in Power Pack, both with forward, reverse and off switch. New Programmer and new special reversing switch set up an entire automatic sequence of movement in powering models! Power-Matic Hoist is also included.

**LESS THAN \$60.00**
**NEW!**



# ERECTOR®



## NO. 10161 ERECTOR

### THE MODEL MAKER'S SET

The all-steel parts in this bright and sparkling carry-home package are all ready to build a Space Ship, Elevated Crane, Water Tower or dozens of other models. Set includes girders, large wheels, pulleys, axles, base plates and other parts.

LESS THAN \$3.00



## NO. 10171 ERECTOR

### THE ENGINEER'S SET

A Rocket Gantry patterned after the kind used at Cape Canaveral is but one of many exciting models this interesting Erector set will make. All-steel parts build and rebuild Robots, Revolving Crane, Mobile Radar Scanner, Jet Bomber plus a host of bridges, docks, cranes.

LESS THAN \$5.00

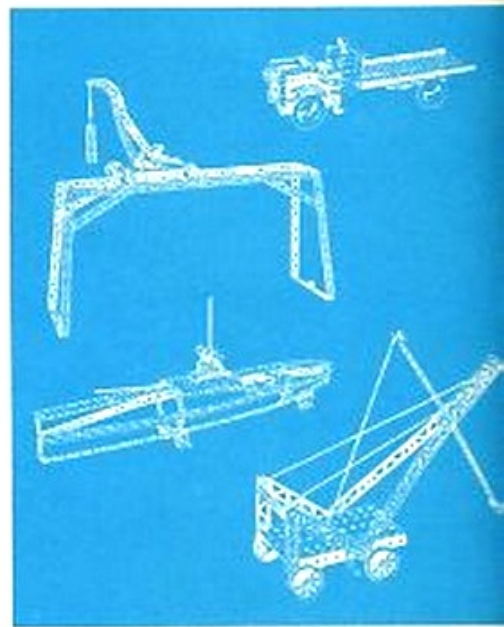

## NO. 10181 ERECTOR

### THE ACTION HELICOPTER SET

Hook up the motor on the giant helicopter and watch the big blades revolve faster and faster. You can build it yourself — with all-steel Erector parts. Set also builds hundreds of other action models, including Automatic Radar Scanner, Airplane Ride, battery-operated truck and many more. Steel chest.

LESS THAN \$11.00

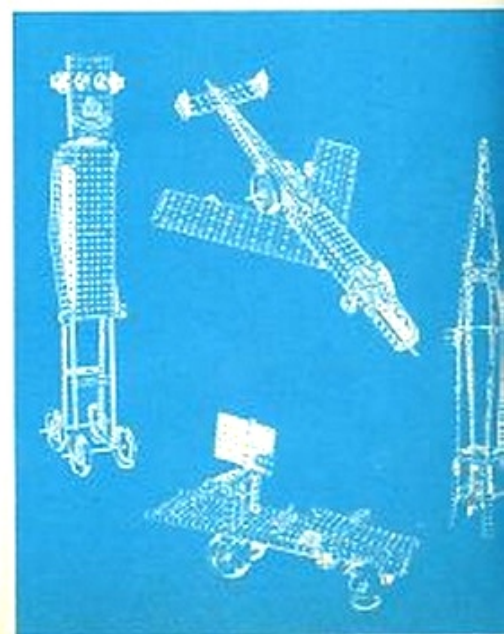



**GILBERT**
**FUN  
IN  
SCIENCE**

# FUN IN SCIENCE

# fun

## IS WHEN YOU'RE MAKING SOMETHING...

...and there's a world of "make" and "do" in this new Gilbert line of FUN IN SCIENCE—endless fascinating hours of profitable projects in electronics, electricity and physics. Every set is in a brand new pilfer-proof, high-visibility, self-sell package.



**No. 15055 FUN IN SCIENCE with Electricity**—Learn safely—and with fun—why electricity behaves as it does! Experiment with static electricity, electro-magnetism, build audio and visual code practice set, make a searchlight, test materials for electrical qualities, and do many other projects. Safe battery power.

**LESS THAN \$5.00**

**No. 15056 FUN IN SCIENCE with Electricity**—All the exciting features of the new No. 15055 set plus many more; make a rheostat, make a battery, make an electromagnetic crane, use compass in magnetism research, etc. Safety-tested—uses dry cell battery power.

**LESS THAN \$10.00**

**No. 15057 FUN IN SCIENCE with Physics**—Easy-to-follow experiments show what happens when certain conditions occur in dynamics, light, optics, fluids and air and water pressures. Safety tested! For boys and girls 10 and up. Laws of physics come alive through fun-to-perform experiments.

**LESS THAN \$13.00**

**No. 15058 FUN IN SCIENCE with Physics.** Crammed with parts, equipment, apparatus for hours of fun—experiments in Solar Heat, Optics, Air and Water, Light Bending, Fluid Dynamics pressure. Includes: radiometer, parabolic reflector, polarizing filters, optical bench, beaker, illuminator, etc., etc.

**LESS THAN \$20.00**

**No. 15059 FUN IN SCIENCE with Elec-Tronics**—Build any one of 9 different electronic circuits in 10 minutes—or less—without tools, solder or technical skill! Just follow "road map" templates and use snap-on jiffy clips for connections, to make broadcasting station, various transistor radio receivers, code practice set, etc.—all fully operational with safe dry cell power (batteries not included).

**LESS THAN \$20.00**

**GILBERT**
**SAFETY  
TESTED**  
 GILBERT HALL  
 OF SCIENCE

# CHEMISTRY



No. 12082 **FUN CHEMISTRY in the Home**—A whole new approach to chemistry sets puts emphasis on the chemistry of common household materials including food testing and analysis. With simple, safe materials you make an "erupting" volcano that really blows its top! Dozens of other fascinating projects. Completely new concept in chemistry set packaging in 5 colors with big appealing "product-in-use" picture on one side, clear plastic window on the other.

**LESS THAN \$4.00**

No. 12083 **FUN CHEMISTRY: Crime Detection & Magic**—Make a real operating home Fire Extinguisher with safety-tested chemicals. Do over 50 chemical "magic" tricks and all sorts of other exciting new projects such as crime detection with chemicals. Another completely new set with emphasis on things to do and learn. Appealing 5-color "show-and-tell" package. **LESS THAN \$5.00**



## NO. 12084 **CHEMISTRY** of Plastic and Glass

Mix your own plastic material with safety-tested chemicals, then—using actual molds provided in the set—make your own plastic boat and automobile. Just one of the exciting new things to do with chemistry that this great new set provides, such as making dozens of fascinating glass objects, etc. Five-color outer display carton, permanent inner steel storage cabinet with heavy plastic window.

**LESS THAN \$10.00**

**GILBERT**
**SAFETY  
TESTED**  
 GILBERT HALL  
 OF SCIENCE

# CHEMISTRY



**No. 12085 CHEMISTRY of Crystals and Color**—Analyze colors with new battery-powered Electro-Chem-Rotor—grow crystals in the weird crystal "garden" tank (like something you'd expect to see on the moon!)—do all sorts of equally exciting projects with this set that's completely new in concept, design and packaging. Outer display carton features big full color illustration, inner steel cabinet offers convenient storage.

**LESS THAN \$17.00**

**No. 12086 CHEMISTRY of Plating and Paints**—Endlessly fascinating things to make and do, that's what you get in full measure with this completely new set. There's an electroplating tank for copper or nickel plating. You can "brush" plate or plate with 24 K gold. You can make and apply bronze finish. You can manufacture paints with new Electro-Chem-Rotor, then use them to paint-by-number. You can study the mysteries of fluorescence with new Black Light "gun". These are only a few of the projects. 5-color display carton encloses permanent steel 2-section cabinet. 72-page instruction manual.

**LESS THAN \$24.00**

**No. 12087 CHEMISTRY of the Space Age**—New and fantastic as tomorrow's front page science stories are the features of this big set! Grow plants space-ship style in tanks without soil with safe atomic-irradiated seeds! Stimulate astonishing speed of growth with new miracle plant nutrients! Study effects of over-balanced plant food! Analyze and mix chemicals with new Electro-Chem-Rotor! Make fluorescent dyes and inks, then study them with "Black Light". Make chemical "Magic". Do glass blowing. Study full color Periodic Table of Elements. 3-section steel cabinet. Big illustrated instruction manual.

**LESS THAN \$30.00**

**No. 12088 CHEMISTRY — Advanced Research Lab**—Completely new-design 4-section steel cabinet opens out to 6 feet, holds the ultimate in chemistry sets designed for young researchers, 12 to 16, with scientific bent. Do many high school chemistry experiments including: Electro-Chemistry, Qualitative and Quantitative Analysis, Metallurgy, Chromatography. Set includes professional-type equipment such as Electro-Chem-Rotor, "Black Light" Gun, Electroplating Brush, Erlenmeyer Flask, Crucible, Ring Stand, Beaker, etc. Giant instruction book.

**LESS THAN \$40.00**



# MICROSCOPES



**No. 13101 MICROSCOPE & Lab Set**—Features a completely new metal instrument that magnifies 60 times actual size. Precise table focusing. Illuminator plugs in household A.C., gives brilliant lighting above or below stage. New 5-color package is pilfer proof with clear acetate window for complete visibility, large product-in-use illustration on opposite side. Box dimensions: 9 $\frac{1}{4}$ " x 12 $\frac{1}{2}$ " x 3 $\frac{1}{2}$ ". **LESS THAN \$7.00**



**No. 13102 MICROSCOPE & Lab Set**—Brand new metal microscope has triple turret offering choice of 60, 90 or 475-power magnification. Set features new Protozoa Pack and Growth Chamber. Observe lowest form of single-celled animal life grow and reproduce, at any time of year! New modular component rack for easily accessible storage. Plug-in A.C. lighting for use above or below stage. **LESS THAN \$10.00**



**No. 13103 MICROSCOPE & Lab Set**—Massive metal instrument has 75, 250 and 500 power magnification, zooms down for small objects and slides, zooms up for larger specimens. Entire optical system shifts around to opposite side for viewing large objects. Revolutionary new packaging includes 5-color outer carton, inner metal case with heavy clear plastic window that slides out to become safe, tidy working surface on which you attach new equipment module. Set also features new Protozoa Pack with special Growth Chamber. **LESS THAN \$15.00**



**No. 13104 MICROSCOPE & Lab Set**—Heavy die-cast metal instrument has quadruple lens turret with magnifying powers of 100, 250, 500 and 1000 times actual size. It has zoom feature, group viewer, and precision optical system that may be shifted to side opposite slide table for viewing unusual rocks, etc. Steel cabinet has clear plastic window that slides out to become handy work surface on which you attach 3 modules containing specimens, apparatus, glass slides, shrimp eggs, etc. Set also has Protozoa Pack and Growth Chamber. **LESS THAN \$20.00**



# MICROSCOPES

Many Sets feature another fascinating Gilbert "First" ... PROTOZOA-- world's smallest living animals. Watch them grow and multiply!



No. 13105 MICROSCOPE & Lab Set—A complete Microscope lab that features massive metal instrument with precision lens system—75, 250 or 500-power magnification—famous Gilbert zoom feature, ability to shift to side opposite slide table when viewing extra large objects, both bi-ocular and monocular eye-pieces, plug-in A.C. lighting. Set includes 4 equipment modules crammed with specimens, equipment and apparatus, stains, dissecting needles, etc. Heavy clear acetate window in steel cabinet slides out to become tidy work surface to which modules may be conveniently attached. Also includes: Protozoa Pack and Growth Chamber, polarizing fillers. **LESS THAN \$28.00**

The finest quality, most versatile Microscopes in the entire world of Science Toys!



**EXCLUSIVE!**  
Optical system shifts around 180° to view large objects



**GILBERT****PRECISION  
LENS  
SYSTEMS**

# TELESCOPES



**No. 13262 60-POWER SPOTTING TELESCOPE**—  
Produces an upright direct image and has 60-  
power magnification. Stands on steel tripod  
and swivels 360°; locks into any position de-  
sired for steady viewing. Ideal for observations  
of land, sea or air objects. Box is 31" x 9½"  
x 4". **LESS THAN \$15.00**

**No. 13241 40-POWER SPOTTING TELESCOPE**—  
Refracting telescope with steel tripod mount  
and precision lens system that produces up-  
right image, is perfect for viewing such ob-  
jects as flying aircraft, ships at sea, distant  
birds, animals or people. Swivels 360°; can  
be locked in any position. Box is 31" x 7½"  
x 2½". **LESS THAN \$10.00**



**No. 13214 80-POWER DELUXE ASTRONOMER'S TELESCOPE**  
with Sun Viewer—Brings exciting close-ups of moons and  
planets. Sharp, clear field of view, positive focusing. Sun  
Viewer attachment permits observations of Old Sol in  
perfect safety. Handsome simulated leather case with  
zipper, 27¾" x 9" x 3½". **LESS THAN \$20.00**

**GILBERT****FAMILY  
FUN**

# PUZZLES



**No. 15023**—Now, attractive set has each  
heavy-gauge metal twister under separate  
bubble on card, with solution on back of each  
so puzzles may be cut apart for individuals.  
Size of card, 9¼" x 9½". **LESS THAN \$1.00**



**No. 15013**—Perennially popular metal  
twisters are now individually bubble-  
packed on heavy card with solutions on  
back. Size of card, 7" x 7½". **LESS THAN 50¢**



# DINKY TOYS



00067



00068



00071



00191



00193



00069



00072



00237

Superb scale models with authentic detail . . . All metal bodies — for amazing durability (they survive almost any kind of punishment!) . . . Meticulous craftsmanship, beautifully finished . . . Real replaceable rubber tires . . . Individually packaged in full-color boxes. Be a collector!



00238



00242



00257



00112



00194



00120



00140



00147



00198



00178



00181



00188



00076



00078



00071



00112



00257



00300



00321



00067



00068



00071



00191



00193



00069

No.	Description	Lgth.	Price
00067	Austin Taxi	2 $\frac{3}{8}$ "	\$ .79
00068	Royal Mail Van	1 $\frac{7}{8}$ "	.69
00069	Massey-Harris-Ferguson Tractor	1 $\frac{1}{2}$ "	.50
00071	Volkswagen Delivery Van	2 $\frac{3}{8}$ "	.65
00072	Bedford Articulated Flat Truck	4 $\frac{5}{8}$ "	.89
00073	Land Rover & Horse Trailer (with Horse)	4 $\frac{5}{8}$ "	1.29
00076	Lansing-Bagnall Tractor & Trailer	2 $\frac{3}{4}$ "	.85
00078	Lansing-Bagnall Trailer only	1 $\frac{3}{8}$ "	.45
00191	Dodge Royal	4 $\frac{1}{2}$ "	1.05
00193	Rambler Cross Country Station Wagon	4"	1.85
00194	Bentley Series S Coupe	4 $\frac{1}{2}$ "	1.95
00198	Rolls-Royce Phantom V	5"	1.95
00237	Mercedes-Benz Racer	3 $\frac{3}{8}$ "	1.00
00238	Jaguar Type D Racer	3 $\frac{1}{2}$ "	1.00
00242	Ferrari Racer	3 $\frac{1}{2}$ "	1.25
00257	Fire Chief's Car	4"	1.10
00112	Austin Healey Sprite Mark II	3 $\frac{3}{8}$ "	1.25

No.	Description	Lgth.	Price
00113	M.G.B. Sports Car	3 $\frac{1}{4}$ "	\$1.65
00120	Jaguar E Type (with detachable hood)	3 $\frac{3}{8}$ "	1.50
00140	Morris 1100	3 $\frac{1}{2}$ "	1.29
00147	Cadillac 62	4 $\frac{1}{2}$ "	1.50
00148	Ford Fairlane	4 $\frac{3}{8}$ "	1.50
00178	Plymouth Plaza	4 $\frac{3}{8}$ "	1.05
00181	Volkswagen	3 $\frac{5}{8}$ "	.75
00188	Four Berth Caravan	5 $\frac{1}{2}$ "	1.69
00258	U.S.A. Police Car	4 $\frac{5}{8}$ "	1.45
00259	Fire Engine	4 $\frac{5}{8}$ "	1.65
00264	R.C.M.P. Patrol Car	4 $\frac{3}{8}$ "	1.85
00265	Plymouth Taxi	4 $\frac{3}{8}$ "	1.45
00276	Airport Fire Tender (Flashing Light)	4 $\frac{5}{8}$ "	3.00
00277	Superior Criterion Ambulance (Flashing Light)	4 $\frac{7}{8}$ "	2.69
00300	Massey-Harris Tractor	3 $\frac{1}{2}$ "	1.50
00321	Massey-Harris Manure Spreader	4 $\frac{3}{4}$ "	1.40



# DINKY TOYS



Many models with authentic working parts for tremendous extra play value . . . Vehicles with Prestomatic Steering, individual wheel suspension, flashing lights, even clear plastic windows that open and close!

No.	Description	Lgth.	Price
00340	Land Rover	3 3/8"	\$1.45
00341	Land Rover Trailer	3 1/8"	.65
00343	Farm Produce Wagon	4 1/4"	1.29
00401	Coventry Climax Fork Lift Truck	4 1/4"	2.25
00405	Universal Jeep	3 3/4"	1.10
00410	Bedford End Tipper	3 7/8"	1.99
00414	Rear Tipping Wagon	4"	1.05
00430	Wrecking Car	4 7/8"	2.25
00651	Centurion Tank	5 3/4"	2.69
00735	Gloster Javelin Delta Wing Fighter	3 1/2"	.79
00737	P.I.B. Lightning Fighter	2 3/4"	.69
00738	DH110 Sea Vixen Fighter	3 3/4"	.95
00786	Tire Rack with Tires	2"	.98
00796	Healey Sports Boat on Trailer	3 3/8"	.95
00822	Half-Track M3	4 7/8"	2.40
00884	Brockway Bridge Transporter with inflatable boats, track sections	7 1/4"	9.00

No.	Description	Lgth.	Price
00437	Muir-Hill 2-WL Loader	4 3/4"	\$2.95
00449	Chevrolet El Camino Pick-Up Truck	4 3/8"	1.50
00532	Lincoln Premiere	4 5/8"	1.65
00533	Mercedes-Benz Coupe 300 SE	4 1/2"	1.70
00552	Chevrolet Corvair	4 1/4"	1.70
00555	Ford Thunderbird	4 7/8"	2.25
00582	Citroen Wrecking Lorry	5"	2.00
00585	Berliet Tipping Truck	5"	4.00
00626	Military Ambulance	4 3/8"	2.10
00893	Pipe-Lines Transporter Unit	8 1/2"	3.60
00948	Tractor Trailer McLean	11 1/8"	5.10
00956	Turntable Fire Escape	7 3/4"	3.85
00958	Snow Plow	7 3/4"	3.75
00960	Albion Lorry-Mounted Concrete Mixer	5 1/8"	2.95
00961	Blaw Knox Bulldozer	5 5/8"	4.80
00965	Euclid Rear Dump Truck	5 5/8"	3.30
00971	Coles Mobile Crane	6 3/8"	3.75



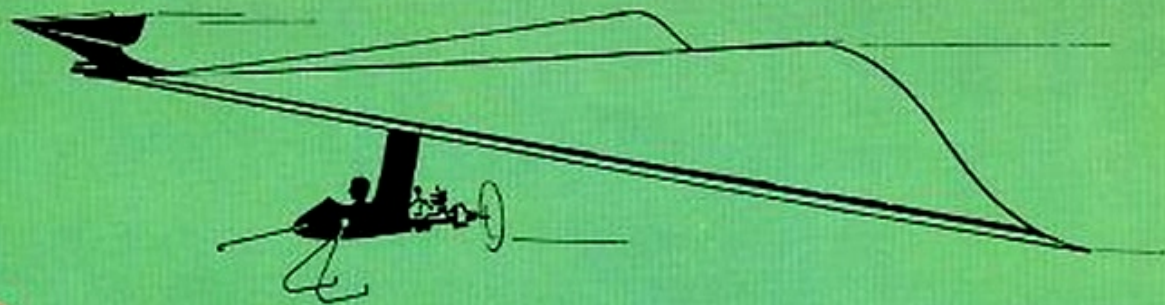

**AMERICAN FLYER®**



**WORLD OF**



**TRANSPORTATION**

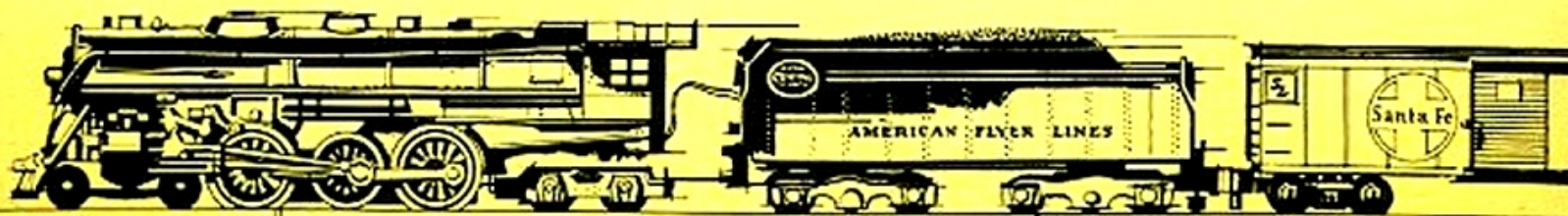

**GILBERT****AMERICAN  
FLYER**

# AIRPLANES

## The Wing Thing

TRADEMARK

The first ALL SEASONS flying vehicle . . . MOST VERSATILE aerial toy ever invented! 4-WAY PERFORMANCE:

- FREE FLIGHT POWERED FLYING •
- TOW LINE GLIDING • SKY-HIGH SAILING • TETHERED POWER FLYING

It soars . . . it spins . . . it loops . . . it glides . . . it flies . . . It's THE WING THING!

No. 40024 Wing Thing—Simple in construction, virtually crash-proof under normal conditions. The Wing Thing consists of a flexible plastic wing, 36" long with 48" spread and a light fuselage on which is mounted a powerful .074 Thunderhead engine.

LESS THAN \$13.00

No. 40026 Wing Thing—Same as No. 40024 but with Starter Accessory Kit of battery, fuel and all equipment necessary to start engine, plus extra glow head.

LESS THAN \$18.00

U.S. Patent No. 2,537,560 and Patents Pending



You change flight characteristics to suit yourself by adjusting a counter-weight on the fuselage.



Fuselage and landing gear, with rugged powerful .074 Thunderhead engine.



"Wing-on-wing" construction prevents any nose dive, provides extra buoyancy.

*New!*

## NO. 40020 MUSKETEER

NEWEST ADDITION TO THE SUPERB  
AMERICAN FLYER FAMILY OF AIRPLANES

A sleek speedster that's styled after a popular Beechcraft business plane, the Musketeer is equipped with a mighty .074 Thunderhead engine that delivers ample power for long control-line flying. It has windows and highly-detailed cockpit interior. Like its sister ships, it has the exclusive Automatic Co-Pilot and removable engine silencer. Fully-assembled plane has starter assembly, heat-treated dacron lines, control handle and adaptors, wrench, customizing kit and complete instructions. Dimensions: wing span, 23"; length 18".

LESS THAN \$20.00

### NO. 40022 MUSKETEER

Same as No. 40020 but with Starter Accessory Kit of battery, fuel and all equipment to start the plane, plus an extra glow head.

LESS THAN \$25.00

GILBERT

AMERICAN  
FLYER

# AIRPLANES



**NEW! No. 40173 Plane-Away.** Now you can fly without a helper! For the first time ever, American Flyer makes possible SOLO control-line flying. Just place your plane on platform with wheel chocks up, lay out lines, start engine, pull on automatic release, chocks drop and—Presto! PLANE AWAY! Adjusts to fit almost any ready-to-fly plane and works on any surface. Dimensions: 13½" x 18". **LESS THAN \$7.00**

**NEW! No. 40175 Bombs Away.** Add new fun and thrills to control-line flying with this exciting new accessory that includes 4 bombs, an automatic bomb release that can be attached to any American Flyer plane and a 36" x 36" target. Fill bombs with flour—they open and mark target on impact. Looks easy—yet it's fun because it takes skill and practice to hit the bulls-eye. Bombs are 6 inches long, rugged, designed for use over and over again. Decals for bombs included. **LESS THAN \$4.00**



**No. 40002 Skystreak.** The thrill of flying the first time out is assured with this speedy Skystreak with its big .074 Thunderhead engine, removable engine silencer, Automatic Co-pilot and other exclusive features. Included with fully-assembled airplane: Starter assembly, automatic co-pilot, heat treated dacron lines, control handle and adaptors, wrench, customizing kit and instructions. Dimensions: wing span, 19½"; length, 18¼". **LESS THAN \$15.00**

**No. 40004 Skystreak.** Same as No. 40002 Skystreak described above, but with Starter Accessory Kit of Battery, Fuel, etc. **LESS THAN \$20.00**

**No. 40008 Skyhawk.** Profiled after a Goodyear racer, this big fully-assembled airplane has powerful .11 engine and all the exclusive features that make Gilbert planes the world's most rugged and easiest to fly. Wing span is 24", length 19½". **LESS THAN \$25.00**

**No. 40010 Skyhawk.** Same as above but with Starter Accessory Kit (all necessary equipment to start airplane, plus extra Glow Head). **LESS THAN \$30.00**

**No. 40012 Skyflash.** Its big new .11 Thunderhead engine delivers ample power for longer control line—and that means easier flying! Fully assembled, with exclusive Automatic Co-Pilot and all the other great Gilbert features. Wing span is 24", length 19½". **LESS THAN \$25.00**

**No. 40014 Skyflash.** Same as above but with Starter Accessory Kit (all necessary equipment to start airplane, plus extra Glow Head). **LESS THAN \$30.00**

## AMERICAN FLYER AIRPLANE ACCESSORIES

<b>No. 40106 .074 Thunderhead Engine,</b> with thrust washer, prop washer, nut, and wrench.	<b>\$ 7.98</b>
<b>No. 40107 .074 Thunderhead Engine.</b> Same as above but with deluxe starter and muffler.	<b>8.98</b>
<b>No. 40108 .11 Thunderhead Engine,</b> with thrust washer, prop washer, nut, and wrench.	<b>9.98</b>
<b>No. 40109 .11 Thunderhead Engine.</b> Same as above but with deluxe starter and muffler.	<b>10.98</b>
<b>No. 40140 Starter Spring.</b> For .074 engines.	<b>.45</b>
<b>No. 40143 Starter Spring.</b> For .11 engines.	<b>.45</b>
<b>No. 40144 Needle Valve and Spring.</b> Fits both .074 and .11 engines.	<b>.98</b>
<b>No. 40163 Propeller.</b> 6/3 for .074 engine.	<b>.45</b>
<b>No. 40167 Propeller.</b> 7/4 for .11 engine.	<b>.50</b>
<b>No. 40169 Propeller</b> for "Wing Thing".	<b>.45</b>
<b>No. 40130 Glow Head w/gasket,</b> for .074 engine.	<b>.98</b>
<b>No. 40132 Glow Head w/gasket,</b> for .11 engine.	<b>.98</b>
<b>No. 40153 Compensator.</b> Automatic co-pilot that prevents over-control by novices. Can be used wherever a bell-crank is required for kits.	<b>.98</b>
<b>No. 40170 Flite-Pak Kit.</b> Includes Battery, Fuel and all necessary equipment to start the airplane.	<b>3.98</b>

NO. 19068

**FLY-OVER 8 RACING SET**

Only Gilbert engineering know-how could produce the great new Fly-Over Chicane—which is the spectacular feature of this exciting Figure 8 layout—and only Gilbert cars, with their exceptional power and rugged D.C. motors, could survive the leap over the gap and keep on racing—time after time after time. You can even make them change lanes in mid-air! And you operate either car independently at all times with remote accelerator, from crawl to spin-out speed, for years of racing fun.

**NO. 19068 SET INCLUDES:**

- 2 Ford Stock Cars, Electric-Powered
- 18 City Curve Roadway Sections
- 2 Sections 5 1/4" Straight Roadway
- 2 Sections 7" Straight Roadway
- 1 Fly-Over Chicane
- Plastic Fence Set
- 2 Accelerator Speed Controls
- 1-amp. D.C. Output Pike Master Power Unit (U.I. and C.S.A. approved)
- Customizing Decal Kit

(Layout requires 32" x 66" area.)



# AUTO-RAMA

TRADEMARK

## MINIATURE RACING

*First Time Ever!*  
**FLY-OVER CHICANE**



*Cars leap the gap . . .  
Change Lanes in mid-air!*

No. 19342 Fly-Over Chicane. One of the most spectacular accessories in table-top racing history is this new jump ramp that permits cars to leap across—and keep right on racing! Comes with two manual switches so you can make your car change lanes in mid-air—and it really takes skill in "driving" when both cars approach the ramp at once. Kit is complete with approach ramp, landing ramp, railings, flags, even operating red warning light. Quickly installed on any American Flyer Auto-Rama race set. . . . . **LESS THAN \$8.00**



Diagram of layout for a single No. 19091 Tri-Oval Trotters Set.



Double your harness-racing fun with 2 No. 19091 sets for spectacular 4-lane, 4-sulky racing.

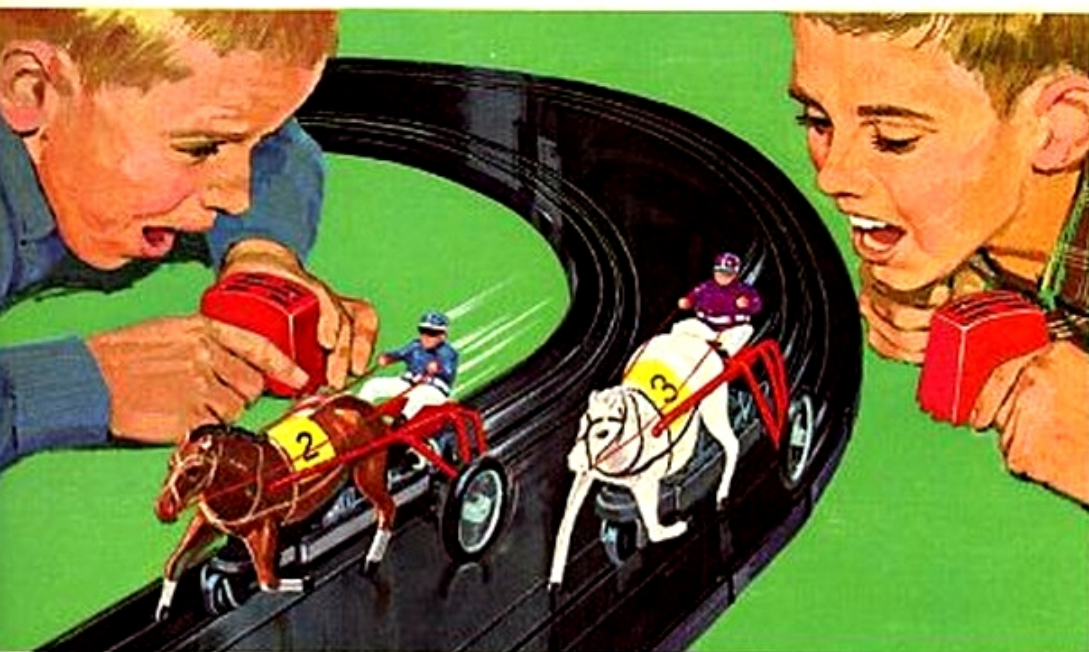

**NO. 19091**  
**TRI-OVAL TROTTERS SET**  
*Harness Racing . . . another American Flyer First!*

Now you can race with authentically styled horse-drawn sulky on an interesting "Tri-Oval" track. Sulky even have a realistic trotting gait! You vary the speed of each rig remotely with a regular Auto-Rama controller. Sulky are equipped with the same powerful, rugged, trouble-free DC motors with worm gear drive that power other Gilbert Auto-Rama vehicles. Complete satisfaction guaranteed!

LESS THAN \$28.00

**No. 19091 SET INCLUDES:**

- 2 Sulky, with a variety of horse colors, electric-powered
  - 6 Outer Race Curve Roadway Sections
  - 6 City Curve Roadway Sections
  - 3 7" Straight Roadway Sections (wired, ready for use)
  - 12-pc. Plastic Fence Set
  - 2 Accelerator Speed Controls
  - 1-amp. DC output Pike Master Power Unit (U.L. and C.S.A. approved)
  - Customizing Decal Kit
- (Layout takes 4-foot square area)



# AUTO-RAMA

## MINIATURE RACING



**NO. 19092**  
**STOCK CAR SPEED BOWL RACING SET**  
*featuring "Which Lane?" Chicane . . . exclusive with Gilbert!*

You NEVER KNOW which way they'll go when the racing Fords reach the special "chicane" section — it's pure chance (and loads of fun!) whether they'll change lanes or not, and there are frequent hair-breadth escapes from crashes when both cars reach the chicane at once. Each "driver" operates his own car independently in either lane, side-by-side or bumper-to-bumper with the exclusive American Flyer roadway system — the only system in which you can control both cars independently while they are on the same lane!

LESS THAN \$28.00

**No. 19092 SET INCLUDES:**

- 2 Ford Stock Cars, Electric-powered
  - 6 Outer Race Curve Roadway Sections
  - 6 City Curve Roadway Sections
  - 2 7" Straight Roadway Sections (wired, ready for use)
  - 2-pc. "Which Lane?" Chicane (exclusive with Gilbert)
  - 2 Accelerator Speed Controls
  - 1-amp. DC output Pike Master Power Unit (U.L. and C.S.A. approved)
  - 12-pc. Plastic Fence Set
  - Customizing Decal Kit
- (Layout requires 36" x 54" area)



Diagram of layout for a single No. 19092 Stock Car Speed Bowl Set.



Fun for Four with 2 No. 19092 Sets! Make a 4-lane race for twice the thrills. (Requires 42" x 60" area)



Make this tremendous double-cross layout by using two No. 19093 sets! It's twice as much fun when four people can play!  
(Layout requires 48" x 72" area)



NO. 19093  
**INDIANAPOLIS 8**  
**RACING SET**

You're at the wheel of powerful Indianapolis racer as it roars up-grade and whips around the elevated turn, then down the hill to the crossroad. Hold it! Slam on the "brakes"! Here comes your opponent's car — looks like a sure collision at the crossing . . . MISSED by a whisker! And the race goes on, with the cars skidding around hairpin curves, up and down the hills, through the crossing on this exciting two-level Figure 8 Speedway, and you control every move with your remote accelerator. Each car has its own rugged, trouble-free DC electric motor with worm gear drive, and is ready to run.

LESS THAN \$35.00

**No. 19093 SET INCLUDES:**

- 2 Indianapolis Racers, Electric-powered
- 18 City Curve Roadway Sections
- 4 7" Straight Roadway Sections (wired, ready for use)
- 1 Crossroad Section
- 14-pc. Plastic Ramp Set
- 66-pc. DeLuxe Metal and Plastic Fence Set
- 2 Accelerator Speed Controls
- 1 1-amp. DC output Pike Master Power Unit (U.L. and C.S.A. approved)
- Customizing Decal Kit.

(Layout requires 30" x 66" area)



# AUTO-RAMA

## MINIATURE RACING



NO. 19094  
**FLY-OVER SPEEDWAY**  
**RACING SET**

Here comes your car . . . skidding around the curve . . . racing up the ramp, and — WOW! It's hurtling the gap! Down she comes, right in the groove, and speeds on down the track! Here comes the other car . . . up — and over — and in mid-air it changes lanes! It's Fly-Over Chicane, the hottest new idea since table-top racing began! It adds a tremendous plus in fun and skill. This great set also includes the new Official Starter PLUS an 80-pc. Accessory Pack of structures including grandstand, position board, observation tower, etc. AND you can make at least four different layouts with this set (see small illustrations at left). Here's fun unlimited — and what a value!

LESS THAN \$45.00

**No. 19094 SET INCLUDES:**

- 2 Ford Stock Cars, Electric-powered
- 18 City Curve Roadway Sections
- 6 7" Straight Roadway Sections (wired, ready for use)
- 2 5½" Straight Roadway Sections
- 1 Crossroad
- 1 Fly-Over Chicane (with banners, decals, etc.)
- 80-pc. Accessory Pack (grandstand, tower, etc.)
- 1 Official Starter, manually operated
- 2 Accelerator Speed Controls
- 66-pc. DeLuxe Metal and Plastic Fence Set
- 1 1-amp. DC output Pike Master Power Unit (U.L. and C.S.A. approved)
- Customizing decal kit.

(Largest layout arrangement requires 48" x 84" area)



**FIGURE 8 WITH CROSSROAD**

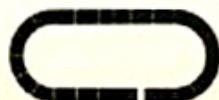

**FIGURE 8 WITH CROSS-OVER AND FLY-OVER CHICANE**

**FIGURE 8 WITH FLY-OVER CHICANE**



**OVAL WITH FLY-OVER CHICANE**



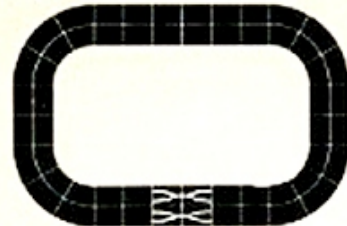

**"ADD-TOGETHER" DESIGN**  
gives you 4-lane, 4-car racing! Imagine the fun and excitement of having FOUR "drivers" competing on the giant track you get when you add two No. 19095 sets together!

(Dual layout requires 60" x 84" area)



NO. 19095

### DUAL "500" RACE SET

Here it is — tops in big-track realism, with just about everything you can think of — even extra Corvette bodies! Set includes both the new American Flyer Lap Counter and Lap Timer, plus new Official Starter, and 80-piece die-cut cardboard Accessory Pack printed in full color that enables you to make big grandstand, tower, etc. For excitement and uncertainty, nothing beats the exclusive Gilbert "Which Lane?" Chicane section that permits cars to change lanes unpredictably in mid-race.

LESS THAN \$50.00

#### No. 19095 SET INCLUDES:

- 2 Deluxe Indianapolis Racers, Electric-powered
- 2 Corvette Bodies (assorted colors)
- 6 Outer Race Curve Roadway Sections
- 6 City Curve Roadway Sections
- 14 7" Straight Roadway Sections (wired, ready for use)
- 2-pc. "Which Lane?" Chicane Section
- 1 Official Lap Counter, automatically operated
- 1 Official Lap Timer, automatically operated
- 1 Official Starter, manually operated
- 80-pc. Accessory Pack (grandstand, tower, etc.)
- 2 Accelerator Speed Controls
- 48-pc. Deluxe Metal and Plastic Fence Set
- 1 1-amp. DC output Pike Master Power Unit (U.L.-C.S.A. approved)
- Customizing Decal Kit

(Layout requires 54" x 78" area)



# AUTO-RAMA

## MINIATURE RACING



NO. 19096

### SUPERHIGHWAY

Independently controlled vehicles go ahead at all speeds, back up and turn around, go right or left at intersections — do everything real cars and trucks will do (even race side by side!) — on this AUTO-RAMA Superhighway system! You control the Corvette and Truck independently of each other with remote accelerator and reversing switch, from crawl to racing speed.

LESS THAN \$60.00

#### NO. 19096 SET INCLUDES:

- 1 Truck, Electric-powered
- 1 Corvette, Electric-powered
- 21 City Curve Roadway Sections (wired, ready for use)
- 5 5½" Straight Roadway Sections
- 3 7" Straight Roadway Sections
- 2 "T" type Roadway Intersections
- 14 pc. Plastic Ramp Set
- 2 Accelerator Speed Controls
- 1 Reversing Switch
- 84 pc. Deluxe Metal and Plastic Fence Set
- 1 1-amp. D.C. output Pike Master Power Unit (U.L.-C.S.A. Approved)
- Customizing Decal Kit

(Layout requires 42" x 66" area)



Bumper-to-bumper, truck follows sports car, ready to turn off at next intersection . . . . .

. . . . . which appears in just a moment. Corvette makes turn, too, heading for home and a warm garage.

Corvette stops just in time as truck makes high-speed turn on to main artery.

Busy intersection! Sports car swings onto turnpike while loaded truck passes in opposite direction.

No. 19339 Automatic Lap Counter. Add a big plus to your racing fun with this colorful new accessory — cars themselves strike paddle suspended over each lane, automatically changing lap number on top. Adjusts to fit all car types and all popular makes of table-top racing roadway. . . \$4.98

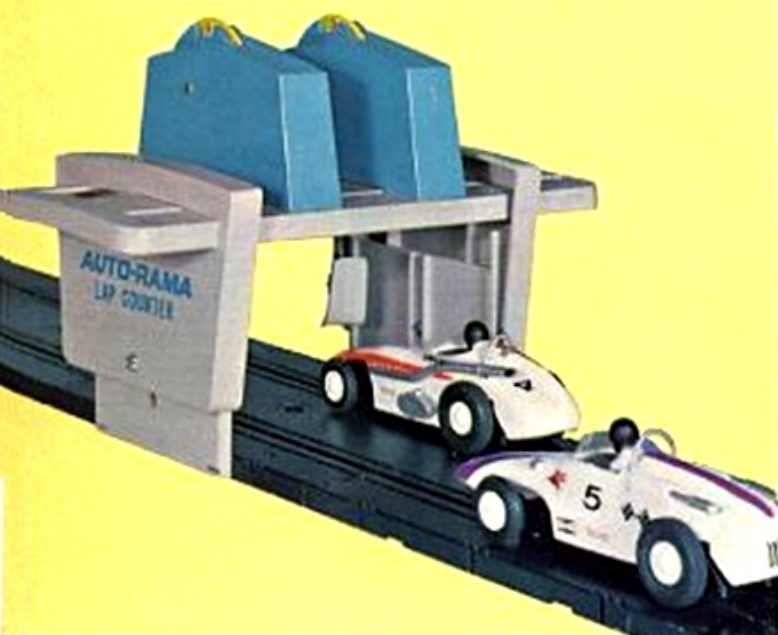

No. 19338 Official Lap Timer. Racing's so much more fun when you can accurately time the laps in actual or scale minutes and seconds with this new Auto-Rama accessory that cars themselves activate by striking metal rod extending across roadway. May be used with all popular makes of racing sets. . . . . \$5.98

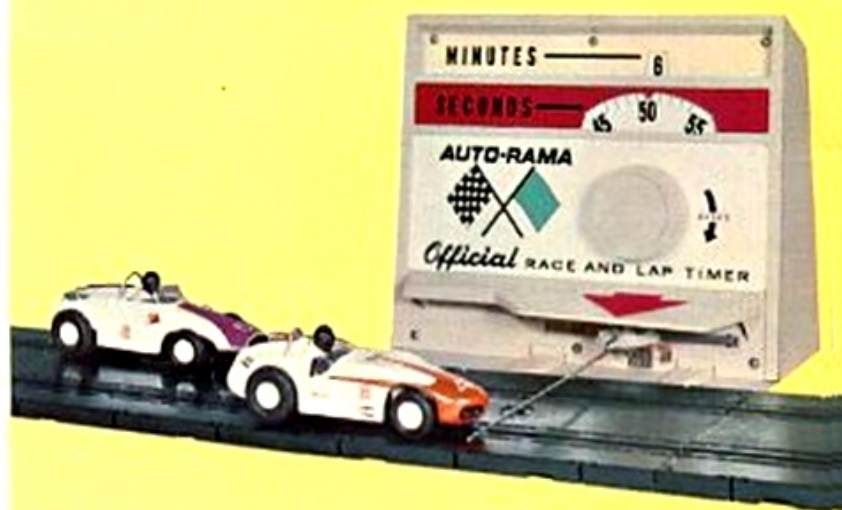

# AUTO-RAMA ACCESSORIES



No. 19341 Hump Bridge Kit. Adds a lot of color and interest to your layout — and takes extra skill, too. Quickly and easily assembled. Requires 3 straight Auto-Rama roadway sections (not included) . . . . . \$1.98



No. 19340 Grandstand Kit. A colorful addition to any racing set, it's easy and fun to assemble and includes complete set of appropriate signs. Size is 8" long x 4 1/4" wide x 5" high when set up. . . . . \$1.98

No. 19335 Official Starter. You press lever in rear and the man's arm drops to make exact starting and stopping time of each race. 4" high overall. Two flags included — one black and white checkered, one solid green. . . . . \$2.75



No. 19224 Railway-Highway Crossing. Lets you combine your Auto-Rama Superhighway with a model train layout in any of three popular gauges: HO, S, or .027 — gives smooth operation in either direction across intersection. Length is 14" — equivalent of two regular Auto-Rama straight roadway sections. . . . . \$4.98



**NEW! No. 19126 "Offy" Special.** Authentically styled after a famous front-engine Indianapolis-type racing car. 5½" long. \$7.98



**NEW! No. 19127 Buick V-8 Special.** A classic rear-engine racer that really eats up the scale miles, beautifully styled after an actual car. \$7.98

**NEW! No. 19128 Sulkies.** Turn your Auto-Rama set into an exciting harness race with these colorful, speedy horse-drawn sulkies. Pair, \$14.88



All Gilbert cars, trucks and sulkies have rugged, powerful 5-pole D.C. motor with worm gear drive, a costly construction feature that makes them run better, longer! All are complete, ready to run, with customizing kit and decals where applicable.

**No. 19107 1940 Ford Coupe.** 5¼" long. \$6.98



**No. 19125 Blue Corvette Sports Car.** 4¾" long. \$7.98

**No. 19112 Road Service Truck.** Operates on Superhighway System or Race Tracks. 5" long. \$6.98



**No. 19116 Flyer Kart.** \$8.98



# AUTO-RAMA ACCESSORIES

**No. 19228 "Which Lane?" Chicane.** Special roadway sections on which any Auto-Rama car can change lanes in mid-race; it's unpredictable, which is why it adds so much fun to racing. \$4.98



**No. 35780 Loader.** Automatically loads coal into truck (not included). \$5.98



**No. 35759 Drum Loading Conveyor.** Remotely operated by electric power. Less truck, \$9.98



**No. 35241 Turnpike Lamp Set.** 12 volts. Set of 3, \$1.98



**No. 19254 Accelerator Speed Control.** \$2.98



**No. 35249 Lamp Post Set.** 12 volts. Set of 3, \$1.50



**No. 19257 Reversing Switch.** For Superhighway only. \$2.98

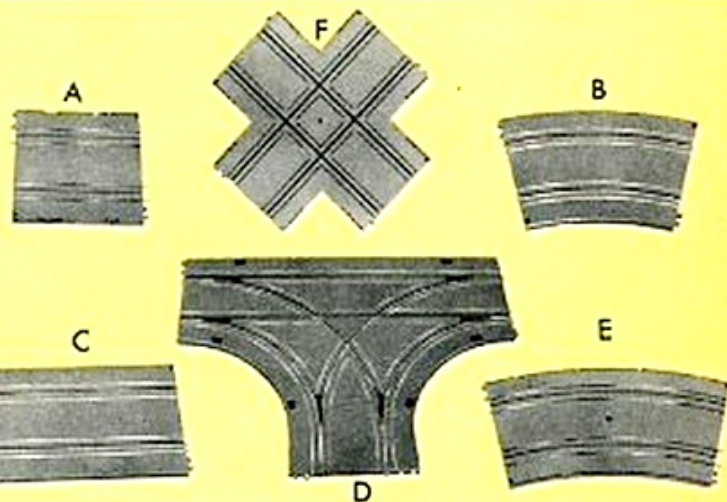

**Roadway Sections for expanding layouts.** (A) 5¼" Straight. Gray: No. 19210; Black: No. 19232; 50¢ each. (B) City Curve. Gray: No. 19216; Black: No. 19233; 50¢ each. (C) 7" Straight. Gray: No. 19209; Black: No. 19231. 50¢ each. (D) "T" Intersection. Gray: No. 19220; Black: No. 19234. \$5.98 each. (E) Outer Race Curve. Gray: No. 19229; Black: No. 19235. 75¢ each. (F) 90° Crossroads. Gray: No. 19225; Black: No. 19237. \$4.98 each.

**Auto-Rama Roadway 2 and 3 Rail Conversion.** To expand your two-rail Racing System into a 3-rail Superhighway and Racing System, please send prepaid to the attention of: Consumer Service Dept., The A. C. Gilbert Company, Erector Square, New Haven 6, Conn., all 2-rail track you wish converted.

Include 30¢ per section for conversion and handling. (Minimum: 12 sections.)

The A. C. Gilbert Company will return to your home PREPAID equal number and style of 3-rail sections plus a conversion kit which will convert any two of the car components you now own to a 3-rail pick-up system.



## "THE CASEY JONES"

**NO. 20763 — AMERICAN FLYER FREIGHT.** The color and romance of the great railroading era in which the legendary Casey Jones made his famous run inspired this colorful freight that's pulled by a 4-4-0 Burlington loco with remote control starting, stopping and reversing plus Pull-Mor power. Rubber-based material on drive wheels gives you better traction than steel

wheels — pulls longer trains at higher speed! Two new cars include Blue B & M Gondola and white box car with red Post Cereal markings. Realistic Pike Master track has only two rails with scale ties — 116 inches of it. Transformer operates train plus three illuminated accessories when desired. Coupling and uncoupling are automatic. **LESS THAN \$20.00**

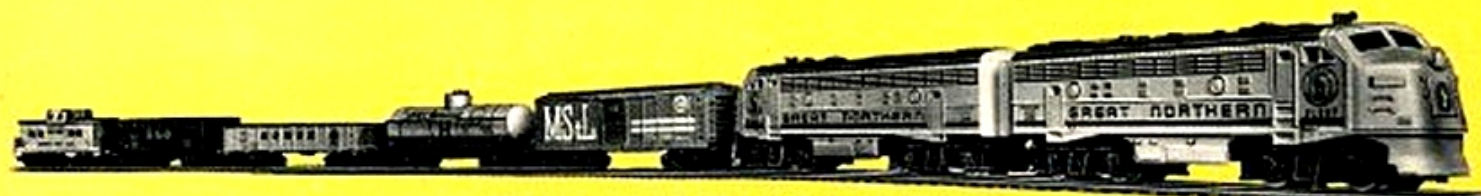

## "THE KLONDIKE"

**NO. 20764 — AMERICAN FLYER FREIGHT.** Head down the high iron to fun with this exciting 7 unit freight train that's powered by a double-unit Great Northern diesel loco (orange, with green markings). It has famous American Flyer Pull-Mor power (better traction enables it to pull longer trains!), and starts, stops and reverses by electric remote control. Colorful

string of cars includes Monon gondola, bright yellow Shell tank car, red M & STL box, B & O hopper and yellow caboose. Super-realistic Pike Master 2 rail track includes special terminal uncoupler section. Transformer has ample power to run train and at least 3 lighted accessories. **LESS THAN \$30.00**



# THE SCALE MODEL LINE



## "THE HAWKEYE"

**NO. 20765 — AMERICAN FLYER FREIGHT.** Here's high stepping action with this powerful remote controlled Southern R.R. loco — watch the giant deluxe detailed side rods churn as she moves out on the mainline, smoke puffing — synchronized to choo-choo sound — and headlight shining down the rails. Loco also boasts Pull-Mor power — rubber-based material on drive wheels, giving far greater traction than steel — for extra speed. **No. 21168 locomotive available separately at \$12.98**

climb and haul. Outfit is complete and ready to roll, with colorful train makeup that includes N.H. car with orange pipes, blue B & M box car, new bright yellow Domino Sugar hopper and red caboose — total of seven units. Set includes 116" of realistic 2 rail Pike Master track, powerful transformer that easily runs train, plus — when added — as many as 3 illuminated accessories. **LESS THAN \$30.00**



## "THE MOHAWK"

**NO. 20766 — AMERICAN FLYER FREIGHT.** The great days of steam railroading are here again with this handsome, husky 4-6-2 Pacific locomotive that puffs real smoke, has built-in choo-choo sound effects, Pull-Mor power, remote control and operating headlight. And rolling along behind are not less than six colorful, detailed, varied cars including auto

transport with removable truck and its load of autos, cream-colored Peabody deluxe hopper, orange Hooker tank, green GN reefer, N&W gondola and bright red deluxe caboose (lighted). Realistic 2 rail Pike Master track makes 136" of running rail — 50 watt transformer has built-in circuit-breaker, is UL/CSA approved. **LESS THAN \$40.00**



## "THE EAGLE"

NO. 20767 — AMERICAN FLYER PASSENGER. Makes you want to climb aboard and ride away to far places in luxury, doesn't it? This Missouri Pacific speedster offers all the features of deluxe passenger operation from the front coupler on the authentic Alco diesel to the fish-tail observation end on the last brilliantly-lighted car, which even has radio

No. 21920 Diesel locomotive available separately at \$24.98

antenna. Loco has working headlight, Pull-Mor power, worm-drive motor, and starts, stops, reverses by remote control. 50 Watt U.L. approved transformer and 136" of realistic 2-rail Pike Master track to put you in the passenger business in a big way.

LESS THAN \$50.00

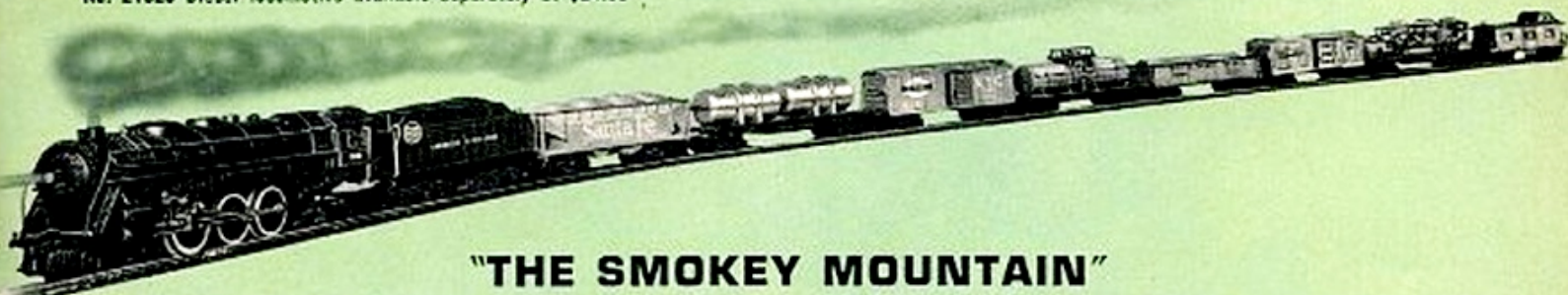

## "THE SMOKEY MOUNTAIN"

NO. 20768 — AMERICAN FLYER FREIGHT. Tremendous is the only word for this outfit that's powered by one of the great model locomotives of all time: the fabulous American Flyer 4-6-4 diecast Hudson — meticulously crafted, superbly detailed, puffing real smoke synchronized with choo-choo sound, with mighty Pull-Mor power and brilliant working headlight. And the load it pulls is one of the longest and most varied in ready-to-run train set history: seven (count 'em!) cars in all, plus deluxe lighted

No. 21130 locomotive available separately at \$34.98

caboose — a train with no less than 10 units, without counting the motor truck on the auto transport with its load of 5 cars, all removable, the two removable jet engines on their I.C. flat car, and the removable girders on the Bethlehem Steel gondola! Set includes 14 sections of flat-top 2-rail, proto-typical Pike Master track that gives you 154" of running rail. Transformer has 50 watt output and built-in circuit-breaker, is U.L. approved.

LESS THAN \$60.00

# S GAUGE TRAINS & ACCESSORIES

## DELUXE PIKE MASTER TRACK



No. 26310

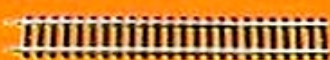

No. 26300



No. 26302



No. 26322

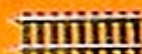

No. 26301



No. 26320



No. 26321

No. 26300	Pike Master 10" Straight Track	30¢
No. 26301	Pike Master 4 1/4" Straight Track	30¢
No. 26302	Pike Master Terminal Straight Track and Uncoupler	\$1.25
No. 26310	Pike Master 12" Curved Track	30¢
No. 26320	Pike Master Right Hand Switch — Remote Control, with separate controller	\$4.98
No. 26321	Pike Master Left Hand Switch — Remote Control, with separate controller	\$4.98
No. 26322	Pike Master 90° Crossing	\$1.50

### NOT ILLUSTRATED:

No. 26323	Pike Master Right Hand Switch — Manual	\$2.98
No. 26324	Pike Master Left Hand Switch — Manual	\$2.98
No. 26340	Pike Master Steel Track Pins, 12 per pkg.	15¢
No. 26341	Pike Master Insulating Pins, 4 per pkg.	15¢
No. 26342*	Pike Master Adaptor Pins, 8 per pkg.	15¢
No. 26343	Pike Master Track Locks, 12 per pkg.	35¢
No. 26344	Pike Master Track Terminals	35¢

\*This pin adapts "Standard S" Track for use with new Pike Master Track.



# S GAUGE ACCESSORIES

## "STANDARD S" TRACK

No. 26760 Remote Control Switches. Positive action electric switches with red and green position lights. Two remote control switch levers. Pr. \$17.98  
 No. 26770 Manual Switches. Control lever works by hand. 10" long. Pr. \$8.98

No. 26745 Railroad Crossing. Allows two main lines to intersect. 10" long. \$2.98

No. 26700 Straight Track. Two-rail "T" track. Heavy gauge steel. 10" 30¢

No. 26710 Half Section Straight Track. Same construction, but 5" long. 30¢

No. 26720 Curved Track. Two-rail "T" track, 10" and fully insulated. Heavy gauge. 30¢

No. 26730 Half Section Curved. Same as above, except 5" long. 30¢

No. 26748 Automatic Car Re-Railer. Permits cars to be railed instantly; just push car through Re-Railer. \$1.98

No. 23024 Rainbow Wire. For wiring accessories on your R. R. layout. Different colors make it simple to trace wires to source. 4 wires, each 25 ft. \$2.98

No. 26746 Rubber Roadbed. Straight section. 40¢

No. 26747 Rubber Roadbed. Curved section. 40¢

No. 26761 Remote Control Switch. Left hand. \$10.98

No. 26762 Remote Control Switch. Right hand. \$10.98

No. 26673 Electric Track Trip. Operates two trains on the same track at same speed; eliminates danger of rear end collisions. Also permits automatic operation of non-automatic accessories. \$3.98

No. 26610 Pow-R-Clips. Simpler, easier, better than any other power lead. Makes positive connection from transformer to track; far less conspicuous, for greater realism. Pr. 25¢

No. 26758 Bumper. Prevents train from running off a dead end siding or terminal. Snaps on track; has warning light, recoil spring. Designed for use with new Pike Master or standard "S" track. \$1.98

No. 26520 Knuckle Coupler Kit. Converts American Flyer link coupler cars to knuckle coupler type. Kit contains one pair. 50¢

## AMERICAN FLYER TRANSFORMERS

No. 22020 50 Watts, with Circuit Breaker \$8.98

No. 22030 100 Watts, with Circuit Breaker \$12.98

No. 22035 175 Watts, with Circuit Breaker \$17.98

No. 22090 Dual Unit Power Controller — 175 Watts each unit \$34.98

## AMERICAN FLYER ACTION CARS

No. 25071 Tie-Jector Car \$4.98

No. 25082 Hay-Jector Car \$4.98

No. 25059 Rocket Launcher Car \$7.98

No. 25058 Lumber Unloading Car \$6.98

No. 25062 Exploding Mine Carrier Car \$7.98

No. 25515 Motorized Rocket Sled \$9.98

No. 23743 Motorized Track Maintenance Car \$7.98

No. 25060 C. B. & D. Coal Dump Car \$7.98

## AMERICAN FLYER ACCESSORIES

No. 23026 Service Kit \$ 2.98

No. 23028 Smoke Dispenser \$ 1.00

No. 23249 Tunnel \$ 2.98

No. 23568 Whistling Billboard \$ 7.98

No. 23571 Truss Bridge \$ 1.50

No. 23581 Girder Bridge	\$ 2.98
No. 23502 Crossing Gate	\$ 4.98
No. 26790 Plastic Trestle Set	\$ 4.98
No. 23761 Semaphore	\$ 8.98
No. 23763 Bell Danger Signal	\$ 5.98
No. 23764 Flasher Signal	\$ 4.98
No. 23769 Aircraft Beacon	\$ 5.98
No. 23772 Water Tower	\$ 5.98
No. 23774 Floodlight Tower	\$ 5.98
No. 23778 Street Lights (3)	\$ 3.98
No. 23788 Suburban Station	\$ 4.98
No. 23796 Saw Mill	\$12.98
No. 23830 Pizzly Back Unloader & Car	\$ 4.98

## AMERICAN FLYER CARS

No. 24054 Sante Fe Hydrocushion Box Car	\$4.98
No. 24065 NYC Box Car	\$4.98
No. 24076 U.P. Steak Car	\$4.98
No. 24103 N & W Gondola	\$3.50
No. 24125 Bethlehem Steel Gondola	\$3.98
No. 24222 Domino Hopper Car	\$3.50
No. 24225 Sante Fe Hopper Car	\$3.50
No. 24230 Peabody Hopper Car	\$3.50
No. 24328 Shell Tank Car	\$4.50
No. 24329 Hooker Chemical Car	\$4.50
No. 24422 Great Northern Reefer	\$4.98
No. 24533 Track Cleaning Car	\$6.98
No. 24539 New Haven Pipe Car	\$3.50
No. 24546 Werk and Boem Car	\$4.98
No. 24549 Floodlight Car	\$5.98
No. 24566 Auto Transport Car	\$4.98
No. 24569 Crane Car	\$6.98
No. 24575 Borden's Milk Car	\$3.98
No. 24578 Corvette Flat Car	\$4.98
No. 24634 DeLuxe Caboose (Red) (Illuminated)	\$5.98
No. 24856 Missouri Pacific Baggage (Illuminated)	\$6.98
No. 24859 Missouri Pacific Coach (Illuminated)	\$6.98
No. 24863 Missouri Pacific Vista Dome (Illuminated)	\$7.98
No. 24866 Missouri Pacific Observation (Illuminated)	\$7.98

## AMERICAN FLYER LAMPS

Lamps are used as follows: 27440, all locomotives. 27441 and 27443, switches. 27444, stations and cars. 27455, use on 26749 and 26756 bumper. 27453, use on 26742 switches. 27458, use on 22040, 22050, 22060 and 22080 transformers. 27641 use on 23769 Aircraft Beacon. 36790, use on Penny switcher locomotive.

No. 27440 Clear Lamp (3)	\$1.05
No. 27441 Red Lamp (3)	\$1.05
No. 27443 Green Lamp (3)	\$1.05
No. 27444 Clear Lamp (3)	\$1.05
No. 27453 Clear Lamp (3)	\$1.05
No. 27455 Red Lamp (3)	\$1.05
No. 27458 Clear Lamp (3)	\$1.05
No. 27461 Clear Lamp (3)	\$1.05
No. 36790 14 Volt Clear (3)	\$1.05



No. 24422 Great Northern Reefer \$4.98

No. 24222 Domino Sugar Car \$3.50

**GILBERT****AMERICAN FLYER**

# HO TRAIN SETS

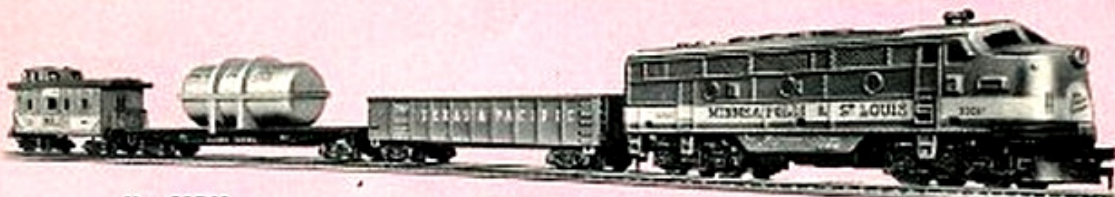

No. 30740

AMERICAN FLYER 4 UNIT "HO" FREIGHT

**"THE NORTH STAR"**

Complete, ready to run. Besides train shown, set includes 11 sec. curved Pike Master track, 18" radius, 1 curved terminal track, Power Pack with 1-amp. A.C.-D.C. output. **LESS THAN \$20.00**



No. 30741

AMERICAN FLYER 7 UNIT "HO" FREIGHT

**"THE DISPATCHER"**

Heavy die-cast metal loco pulls unusually varied train. Set also includes 11 sec. curved Pike Master track with built-in roadbed, 1 curved terminal track, Power Pack with 1-amp. A.C.-D.C. output. **LESS THAN \$30.00**

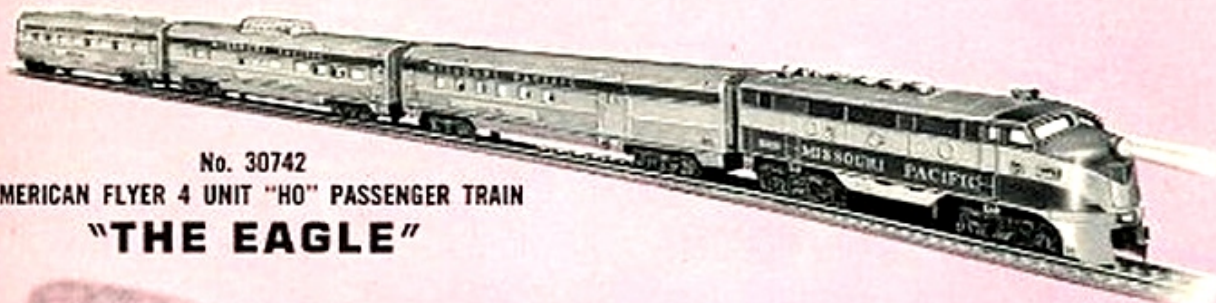

No. 30742

AMERICAN FLYER 4 UNIT "HO" PASSENGER TRAIN

**"THE EAGLE"**

Sleek silver-and-blue streamliner has all cars lighted and is pulled by gear-driven diesel loco with Pull-Mor Power, operating headlight and couplers both front and rear. Complete, ready to run, with 11 sec. curved Pike Master track, 18" radius, 1 sec. straight track, 1 curved terminal track, 1 uncoupler track, 1-amp. Power Pack. **LESS THAN \$35.00**

No. 31039 Diesel Locomotive available separately at \$12.98



No. 30743

AMERICAN FLYER 9 UNIT "HO" FREIGHT

**"OLD SMOKEY"**

You'd almost swear you were back in the colorful days of steam when this beautifully-detailed HO miniature ladder-back 0-6-0 Pennsy switcher chuffs past, smoke puffing and side-rods flashing. Varied load of six cars enables your road to serve no less than six different types of shippers! Cars include new brown N. H. Trap Rock car, bright orange New Haven box, red Mobilgas tank, green

N.Y.C. hopper with removable top, brand new B & O hopper, Borden's milk transport with removable load, and bay window caboose. Set is complete, ready to run, and also includes 11 sec. Pike Master track, 18" radius, 1 sec. straight track, 1 curved terminal track, 1 uncoupler track and 1-amp. Power Pack. **LESS THAN \$40.00**

No. 31004 Pennsy Switcher available separately at \$24.98



No. 30744

AMERICAN FLYER  
10 UNIT "HO" FREIGHT**"THE THUNDERBOLT"**

Railroad buffs consider this one of the truly great steam locomotives of history — the classic 4-6-4 Hudson, and American Flyer recreates its awesome majesty and power in this beautifully-crafted HO scale model of heavy die-cast metal. With smooth-running gear drive, operating headlight, real smoke and synchronized choo-choo sound, it heads up a long string of widely-varied cars — seven

of them, no less, plus bay-window caboose. Included in set are 16 sections of realistic Pike Master Track with built-in roadbed, including a special automatic uncoupler section. Like all American Flyer HO Train sets, it's complete with Power Pack and ready to run. **LESS THAN \$50.00**

No. 31005 Hudson Locomotive available separately at \$29.98



# AMERICAN FLYER HO

## DELUXE HO PIKE MASTER TRACK 3-IN-ONE! Rails, Ties, Roadbed

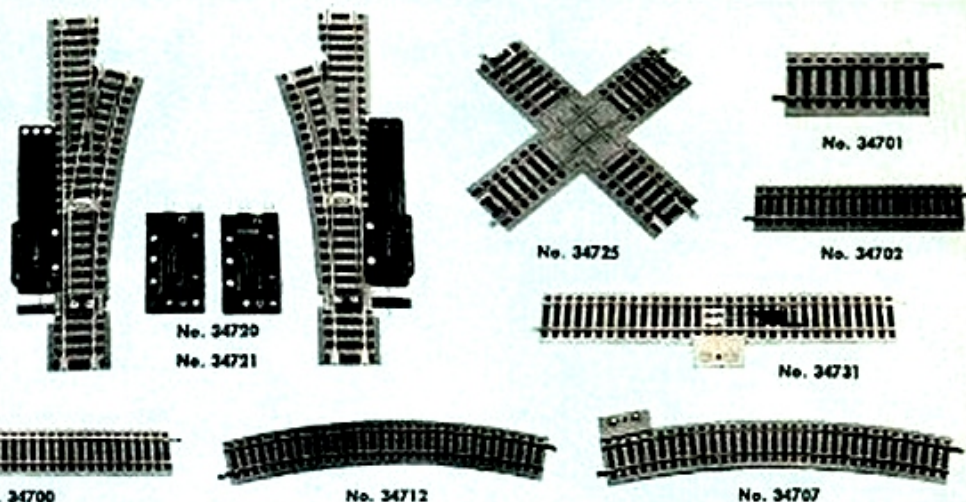

*Designed to work well with any other HO Track on the market!*

- No. 34700 Pike Master HO 9" Straight Track. . . . . 30¢
- No. 34701 Pike Master HO 3" Straight Track. . . . . 30¢
- No. 34702 Pike Master HO 6" Straight Track. . . . . 30¢
- No. 34707 Pike Master HO Curved Terminal Track, 18" radius. . . . . 75¢
- No. 34711 Pike Master HO 1/2 Curved Track, 18" radius (not illus.). . . . . 30¢
- No. 34712 Pike Master HO Curved Track, 18" radius. . . . . 30¢
- No. 34720 Pike Master HO Electric Remote Control switch, Right Hand. . . . . \$4.98

- No. 34721 Pike Master HO Electric Remote Control Switch, Left Hand. . . . . \$4.98
- No. 34722 Pike Master HO Manual Switch — Right Hand (Not illus.). . . . . \$2.98
- No. 34723 Pike Master HO Manual Switch — Left Hand (Not illus.). . . . . \$2.98
- No. 34725 Pike Master HO 90° Crossing. . . . . \$2.25
- No. 34729 Pike Master HO Uncoupler Track. . . . . 98¢
- No. 34731 Pike Master HO Signal Operating Track. . . . . \$2.25

## AMERICAN FLYER HO ACCESSORIES

### POWER PACKS

- No. 32654 Rectifier, 3-amp. D.C. output. With circuit breaker. . . . . \$7.98
- No. 32662 Pike Master Power Pack, 1 1/2-amp. 12-volt D.C., 16-volt A.C. output. circuit breaker. . . . . \$12.98
- No. 32656 Twin Pike Master Power Pack. Dual controls, circuit breaker. . . . . \$24.98

### ACTION CARS

- No. 33804 Exploding T.N.T. Car. . . . . \$7.98
- No. 33806 Mine Exploding Car. . . . . \$7.98
- No. 33812 Rocket Launcher Car. . . . . \$7.98
- No. 33818 Hay-Jector Car. . . . . \$4.98
- No. 33820 Tie-Jector Car. . . . . \$4.98
- No. 33835 Automatic Hopper Car. . . . . \$2.98

### ACCESSORIES

- No. 35201 Trestle Extension. . . . . 88¢
- No. 35202 Bumper (Lighted). . . . . 88¢
- No. 35203 Trestle & Bridge Set. . . . . \$3.98
- No. 35204 Automatic Electric Crossing Signal. . . . . \$2.98
- No. 35205 Block Signal (Electric—wired for automatic or manual operation). . . . . \$3.98
- No. 35206 Water Tower (with operating light). . . . . \$1.98
- No. 35207 Floodlight Tower (with 2 operating lights). . . . . \$2.98
- No. 35208 Truss Bridge (with operating red light). . . . . \$3.98
- No. 35209 Rotating Beacon (operating light rotates automatically). . . . . \$4.98
- No. 35210 Radar Tower (with rotating antenna and light). . . . . \$4.98
- No. 35211 Signal Bridge. (trains stop on red, go on green light). . . . . \$5.98
- No. 35212 Automatic Crossing Gate. . . . . \$4.98
- No. 35213 Oil Storage Depot (with operating lights). . . . . \$2.98
- No. 35214 Automatic Crossing Watchman (pops out when train passes). . . . . \$6.98
- No. 35240 Lamp Posts (lighted—set of three). . . . . \$1.50
- No. 35241 Turnpike Lamps (lighted—set of three). . . . . \$1.98

### ILLUMINATED KITS

- No. 35250 Dutch Colonial House. . . . . 98¢
- No. 35251 Ranch House. . . . . 98¢
- No. 35252 Cape Cod House. . . . . 98¢

### ILLUMINATED KITS (con't)

- No. 35253 Split Level House. . . . . 98¢
- No. 35254 Suburban Station. . . . . 98¢
- No. 35255 Factory. . . . . \$1.29
- No. 35270 Water Tower. . . . . 98¢
- No. 35271 Floodlight Tower. . . . . \$1.49
- No. 35272 Truss Bridge. . . . . \$1.69
- No. 35273 Rotating Radar Tower. . . . . \$1.98
- No. 35274 Signal Bridge. . . . . \$3.50
- No. 35275 Billboard. . . . . 98¢
- No. 35276 Hiway Lights (3). . . . . \$1.49

### OPERATING ACCESSORIES

- No. 35759 Drum Loading Conveyor. . . . . \$9.98
- No. 35780 Coal Loader. . . . . \$5.98
- No. 35785 Coal Unloader. . . . . \$4.98
- No. 35790 Piggy Back Unloader and Car. . . . . \$4.98

### CARS

- No. 33009 Wabash Stock Car. . . . . \$2.98
- No. 33010 Union Pacific Stock Car. . . . . \$2.98
- No. 33012 Santa Fe Hydracushion Box Car. . . . . \$2.98
- No. 33121 New Haven Trap Rock Car. . . . . \$2.50
- No. 33215 Peabody Hopper Car. . . . . \$2.50
- No. 33217 NYC Cement Car. . . . . \$2.98
- No. 33312 Karo Syrup Tank Car. . . . . \$3.98
- No. 33516 NYC Caboose—(illuminated). . . . . \$4.98
- No. 33517 Mobil Gas Tank. . . . . \$3.98
- No. 33521 Northern Pacific Reefer. . . . . \$2.98
- No. 33537 Track Cleaning Car. . . . . \$6.98
- No. 33538 Missile Transport Car. . . . . \$3.98
- No. 33545 Berden's Milk Car. . . . . \$2.98
- No. 33546 Jet Engine Transport Car. . . . . \$2.98
- No. 33548 Crane Car. . . . . \$6.98
- No. 33549 Work and Boom Car. . . . . \$3.98
- No. 33721 Missouri Pacific Baggage & Club (illuminated). . . . . \$5.98
- No. 33722 Missouri Pacific Coach (illuminated). . . . . \$5.98
- No. 33723 Missouri Pacific Vista Dome (illuminated). . . . . \$6.98
- No. 33724 Missouri Pacific Observation (illuminated). . . . . \$6.98

## AMERICAN FLYER HO PIKE MASTER POWER PACKS



No. 32656 Twin Pike Master Power Pack. Run two trains at the same time at different speeds with this dual power pack that includes built-in thermostatic circuit-breaker, two separate throttle controls and two reversing switches. Reduces 110-120 AC to 16 volts AC for accessory operation and to 12 volts DC for trains. **\$24.98**



No. 32662 1 1/2 Amp. Pike Master Power Pack. Reduces 110-120 volt household AC to 12 volts DC for train operation and to 16 volts AC for accessories. Built-in thermostatic circuit-breaker guards against shorts and overloads. Throttle control and reversing switch. **\$12.98**

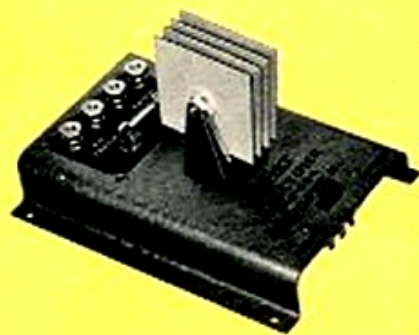

No. 32654 Rectifier. Changes AC from transformer to low voltage DC for train operation. 3 amp. output. Has reset type circuit-breaker 3 3/8" high, 4 5/8" wide, 6 1/4" long... **\$7.98**



No. 33010 Union Pacific Stock Car. New, bright yellow rolling palace for contented bovines. Red markings. **\$2.98**



No. 33521 Northern Pacific Reefer. Beautifully detailed scale model with bright orange sides, red top and ends. **\$2.98**



No. 33012 Santa Fe Hydrocushion Box Car. The latest in freight transport equipment is reproduced in colorful detail in this scale model of a new-type car by A. T. & S. F. **\$2.98**



No. 33517 Mobilgas Tank Car. Your pike can get its share of the oil business with this handsome red, white and black tanker. **\$3.98**



No. 33121 N. H. Traprock Car. Serve another industry on your pike with this gondola that gets a lot of quarry business. **\$2.50**

IF PRODUCT OR PERFORMANCE DEFECTIVE  
Good Housekeeping  
GUARANTEES  
REPLACEMENT OR REFUND TO CONSUMER



*It's a train set...it's a game...it's 3 games in one...it's the new*  
**NO. 20800 GAME TRAIN**

Never before in model railroading . . . a complete American Flyer S gauge train set PLUS over 100 more pieces to play THREE different fun-packed games! *No. 1 — Race with Casey Jones* from New York to San Francisco . . . as the glass ball rolls on the game board map — that's where the train stops! *No. 2 — Buffalo Hunt* takes you out West where the buffalo are — a real skill and speed game. *No. 3 — FREIGHT AHEAD:* Watch the flagman as he tells you to "pick

up freight" — where and how much! You're a railroad tycoon fighting for freight business. Set includes steam loco and tender, gondola car, caboose, 10 sections of realistic 2-rail Pike Master Track, and transformer — plus 22" x 15" U. S. map game board in full color, railroad track marker sections, city cards, buffalo cards, loco markers, flagman, freight revenue chart, etc. Fun for all the family — children and grownups — from one to six people can play!

LESS THAN \$25.00